

# PDA200/2, PDA500/2, PDA1000/2

## PROFESSIONAL AUDIO-FREQUENCY INDUCTION LOOP AMPLIFIERS

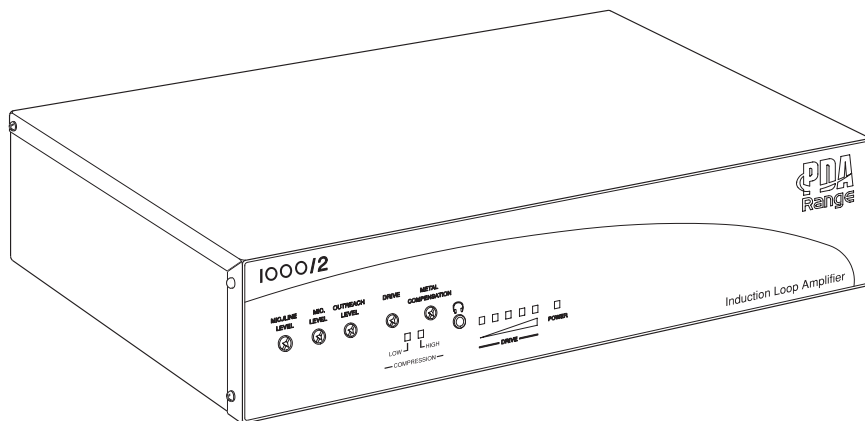

## INSTALLATION INSTRUCTIONS

*This equipment must be installed by a suitably skilled and technically competent person. Please read these instructions carefully before installation.*

<b>Important notes .....</b>	<b>2</b>
<b>What is an audio frequency induction loop system? .....</b>	<b>3</b>
<b>Familiarisation with your PDA Pro-Range induction loop amplifier .....</b>	<b>4</b>
<b>Planning the system .....</b>	<b>6</b>
<b>Overview of the 'Outreach plate' audio input extension system .....</b>	<b>7</b>
<b>A typical PDA Pro-Range induction loop system .....</b>	<b>8</b>
<b>Installation .....</b>	<b>11</b>
<b>Safety precautions .....</b>	<b>11</b>
<b>Mounting the amplifier .....</b>	<b>11</b>
<b>Connecting and testing the system .....</b>	<b>12</b>
<b>Technical specification .....</b>	<b>14</b>
<b>Spares and accessories .....</b>	<b>16</b>



## Important notes

These instructions are general and cannot be considered to cover every aspect of audio-frequency induction loop system design and installation.

We recommend you read BS7594 (The Code of Practice for Audio-Frequency Induction Loop Systems) and EN60118-4 (Magnetic field strength in audio frequency induction loop systems for hearing aid purposes), copies of which are available from the British Standards Institute, Customer Services Department, 389 Chiswick High Road, London W4 4AL.

Tel: +44 (0)20 8996 9000. Web: [www.bsi-global.com](http://www.bsi-global.com). It should be noted that all of the above documents can be subject to update or revision at any time and we recommend you check the status of them with the British Standards Institute before designing or installing the system.

Other National standards of design, installation and commissioning should be referenced where pertinent.

No responsibility can be accepted by the manufacturer or distributors of this equipment for any misinterpretation of an instruction or guidance note or for the compliance of the system as a whole.

This induction loop amplifier **MUST** be installed and maintained by a suitably skilled and technically competent person.

This document must not be left accessible to the user.

## Equipment guarantee

This equipment is not guaranteed unless the system is installed and commissioned in accordance with National standards by an approved and competent person or organisation.



This product has been manufactured in conformance with the requirements of all applicable EU directives.



**IMPORTANT : THE INDUCTION LOOP AMPLIFIER SHOULD NEVER BE OPERATED WITHOUT A LOOP CONNECTED TO IT.**

## What is an audio frequency induction loop system?



An audio-frequency induction loop system (AFILS) allows hearing impaired people to hear more clearly.

Most hearing aids have a 'T' or 'MT' switch which allows them to pick up the electromagnetic field generated by an induction loop system. The hearing aid converts this signal into a sound suited to its user's specific hearing requirements.

Any hearing impaired person positioned within or near the loop can hear the loop signal by switching their hearing aid to the correct position, allowing them to participate more effectively in general conversation, ordering goods or services, listening to public performances, etc.

An induction loop system therefore comprises four main elements:-

**The audio source** – typically a microphone, television or radio (or a combination of these).

**The induction loop amplifier**

**The loop** – typically a single turn of wire usually run around the perimeter of the room.

**The receiver(s)** – any hearing aid with a 'T' or 'MT' switch.

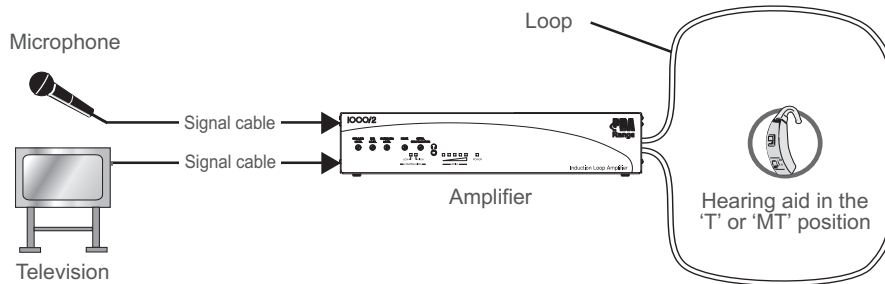

In addition to having a mic. and a mic./line input (which allows the above system configuration to be easily implemented), all PDA Pro-Range amplifiers also have an 'Outreach' socket. This socket offers full compatibility with our unique Outreach plate audio input extension system and allows the connection of multiple microphone and/or line level inputs via a range of specially designed single gang connector plates. For further details please refer to page 7.

## Familiarisation with your Pro-Range induction loop amplifier

Below and overleaf is an overview of the indicators, controls and connectors available on your PDA Pro-Range induction loop amplifier. Detailed connection diagrams, system planning and system set-up information can be found later in this manual.

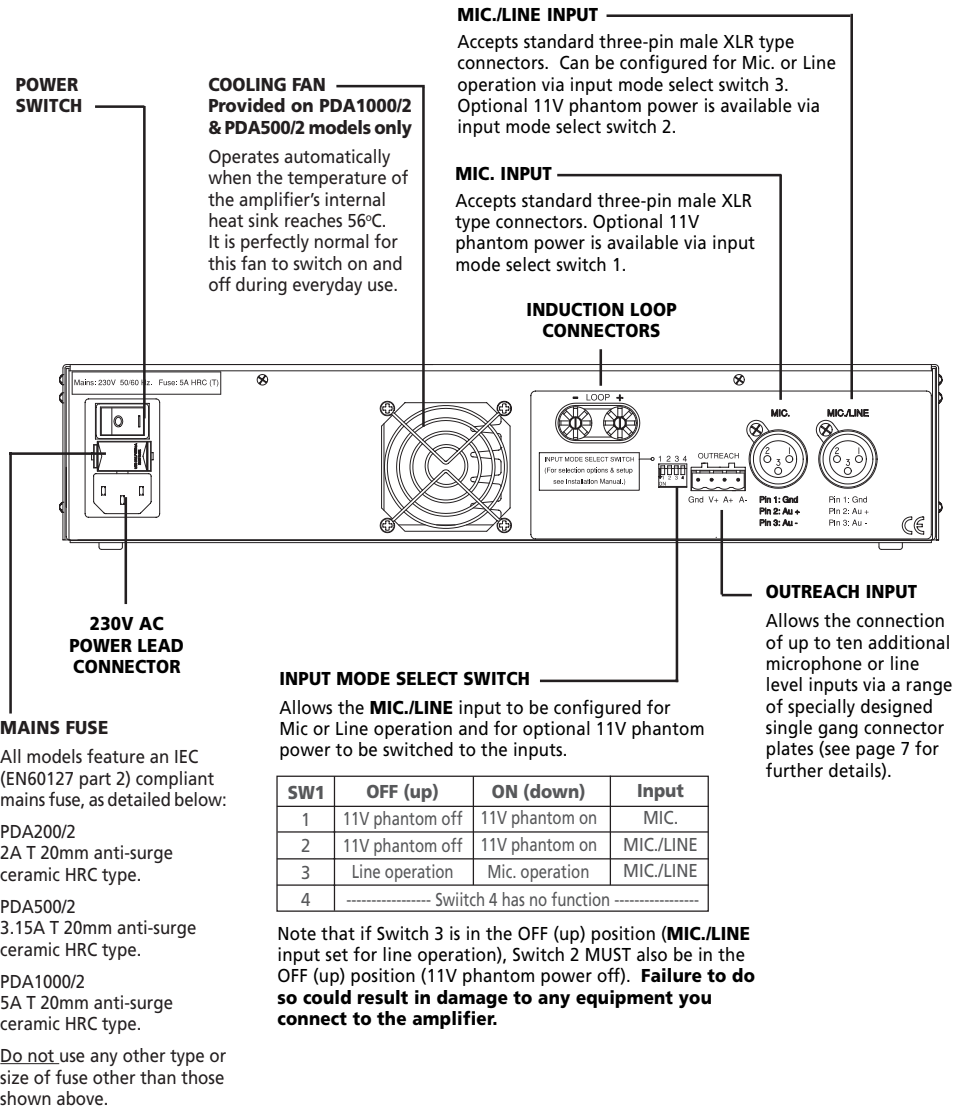

### MODEL NUMBER

Indicates the model number of the amplifier. Variants include the PDA200/2 (for areas up to 200m<sup>2</sup>), the PDA500/2 (for areas up to 500m<sup>2</sup>) and the PDA1000/2 (for areas up to 900m<sup>2</sup>).

### LOOP DRIVE CONTROL

Used to adjust the strength of the magnetic field generated by the induction loop. Turn clockwise to increase the amount of electrical current that is being driven into the induction loop or anti-clockwise to decrease it. Always refer to the amplifier's loop strength meter when adjusting this control.

### METAL COMPENSATION CONTROL

Used to help combat the frequency response problems associated with applications where there is excessive metal 'absorbing' the magnetic field. See page 13 for further details.

### 3.5mm LOOP OUTPUT MONITORING SOCKET

Allows the loop current/audio signal that is present in the induction loop to be monitored using a pair of 32 Ohm headphones. Note that the sound you hear will be a true representation of the signal running through the loop and NOT a representation of what hearing aid users will hear after factors such as metal absorption and their position in the room are taken into account. You MUST still assess the loop signal in the covered area as described in **connecting and testing the system**, pages 10-13.

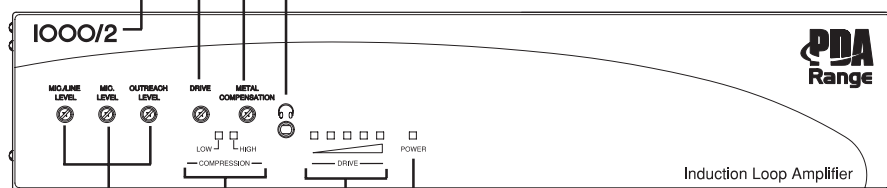

### POWER ON INDICATOR

Illuminates red when the amplifier is powered up.

### LOOP STRENGTH (DRIVE) METER

Gives a visual indication of the current being driven into the induction loop. In normal circumstances, the far right red LED should only illuminate with peaks in the input signal. Installers should refer to these indicators when using the amplifier's loop drive control.

### COMPRESSION INDICATORS

Give a visual indication of the amplifier's compressor activity. Installers should refer to these indicators when using the amplifier's input signal level controls.

For best results, we recommend you set the inputs so that the **LOW** compression indicator is lit most of the time and the **HIGH** compressor indicator illuminates only with peaks in the input signal.

### INPUT SIGNAL LEVEL CONTROLS

Can be used to adjust the sensitivity of the three input signals (**MIC.**, **MIC./LINE** and **OUTREACH**).

Turn clockwise to increase sensitivity or anti-clockwise to decrease sensitivity.

For optimum performance, always refer to the amplifier's **COMPRESSION** indicators when adjusting these controls (see right).

Depending on the number of inputs connected to the amplifier, these controls can also operate as a simple mixer with any changes having a cumulative affect on the output signal.

## Planning the system

Induction loop system design and installation can be simple provided a few basic facts are understood. To help avoid poor performance and the need to re-position the amplifier or loop cable at a later stage, please read pages 6 to 9 before proceeding.

### Area of coverage

Maximum square room coverage provided by PDA Pro-Range amplifiers is as follows:-

**PDA200/2** = 200m<sup>2</sup> (14m x 14m); **PDA500/2** = 500m<sup>2</sup> (22m x 22m); **PDA1000/2** = 900m<sup>2</sup> (30m x 30m)

For rectangular (2:1) aspect ratio coverage see **technical specifications**, page 14/15.

Note that the system may not have to cover the whole of a room. For example, churches may only require coverage in the pews. Seek advice from the relevant authorities before installation begins.

### Loop cable selection

Almost any single core tri-rated cable can be used for the induction loop provided it is of the appropriate DC resistance (ideally 0.5 to 1 Ohm).

The graph on the right shows the recommended CSA for different lengths of loop cable. Simply work out the length of the loop required and choose a cable size that falls into the non-shaded area of the graph.

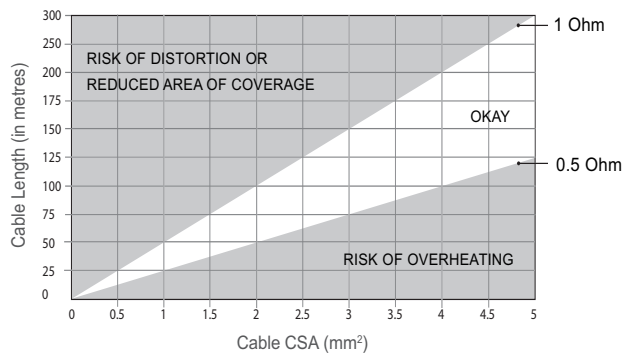

For example, to cover a room 30m x 20m

(600m<sup>2</sup>) the loop cable would need to be 100m long (2 sides @ 30m and 2 sides @ 20m). The recommended cable CSA for a loop this length is between 2mm<sup>2</sup> and 4mm<sup>2</sup>. Therefore, a PDA1000/2 (which can cover areas up to 900m<sup>2</sup>) using 2.5mm<sup>2</sup> cable would be sufficient.

### Loop cable position

The field strength in the plane of the loop (the height at which the cable is positioned) varies greatly so it is best to install the loop above or below the listener at floor or ceiling height (2.5m max.) - the loop field will not be as strong but it will be much more even and give better results for the user(s). Note that listening height (with the hearing aid user sitting or standing) is normally 0.9 to 1.8m from the floor.

With floor loops, avoid running the loop up and over door openings as the signal strength in the doorway will be excessively strong and may cause discomfort to the users.

Large amounts of metal can affect the strength of the loop field so avoid running loops along girders or under floor mesh. If unavoidable, the amplifier's metal compensation control can help combat the frequency response problems associated with such installations, but overall current capability may be reduced, see page 13 for details.

### Trial loops

Always run a trial loop and evaluate performance by listening to the signal with a hearing aid or a dedicated loop test receiver. For compliance with BS7594, we recommend you also test the system using a pink noise generator and magnetic field strength meter, as described on page 13.

### Overspill and 'cross-talk'

The signal generated by the loop will radiate outside as well as inside the loop. If there are other loop systems in close proximity, overspill such as this may lead to 'cross-talk' (signals from different loops merging into one). If this is likely to be an issue, special designs of loop can be implemented to help reduce the overspill field - contact your supplier for details.

### The 'Outreach' plate audio input extension system

In addition to the amplifier's two XLR inputs (**MIC.** and **MIC./LINE**), up to 10 additional microphone or line level inputs (any mix) can be daisy-chained to the amplifier's '**OUTREACH**' connector via a range of specially designed wall, ceiling or desk mountable single gang plates.

Several different Outreach plates are available covering the most common variants of audio connector (see below) and cable lengths of up to 100m (total network length) are easily achievable using standard two pair audio cable such as Belden 8723. See typical wiring diagram below.

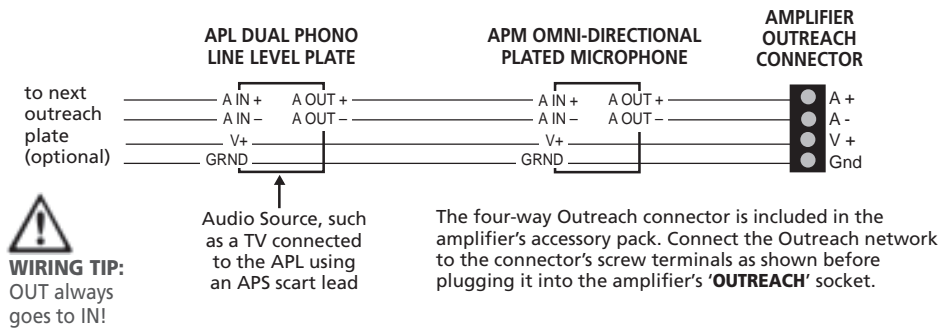

Mountable on 25mm surface back boxes, Outreach plates can be located at any convenient point on an installation, overcoming the need for excessively long microphone or audio leads.

### Outreach plate variants

#### APM OMNI-DIRECTIONAL PLATED MIC

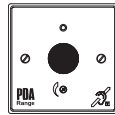

A self-contained omni-directional electret microphone complete with onboard mic to line level converter. Typical coverage up to 25m<sup>2</sup> when located at a ceiling height of 2.5-3m.

#### APXM XLR 3 PIN MICROPHONE PLATE

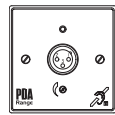

Accepts balanced or unbalanced microphones with standard 3 pin XLR connectors. Includes an on-board mic to line level converter, high gain pre-amplifier and 8V phantom power.

#### APL DUAL PHONO LINE LEVEL PLATE

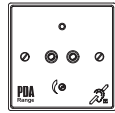

Accepts dual phono line-level signals (usually from a stereo source such as a TV). Includes an on-board dual phono to mono converter. (An APS SCART to dual phono lead is also available to facilitate the connection of TVs, etc).

#### APXL XLR 3 PIN LINE LEVEL PLATE



Accepts standard 3 pin XLR feeds from audio equipment such as stage or church mixing desks, etc.

#### APJ 3.5mm MICROPHONE JACK PLATE

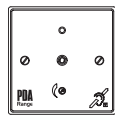

Accepts unbalanced electret microphones with 3.5mm mono jack plugs. Includes an onboard mic to line level converter, high gain pre-amplifier and 8V phantom power.

#### APQL 6.35mm (1/4") LINE LEVEL PLATE



Accepts 6.35mm (1/4") jack feeds from audio equipment such as stage or church mixing desks, etc.

#### APQM 6.35mm (1/4") MICROPHONE JACK PLATE



Accepts balanced or unbalanced electret microphones with 6.35mm (1/4") jack plugs. Includes an on-board mic to line level converter, high gain pre-amplifier and 8V phantom power.

#### API 'AFILS ACTIVE' PLATE

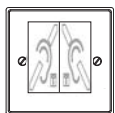

Includes two ultra-bright LEDs in a translucent diffuser overprinted with the induction loop 'ear' symbol. The LEDs illuminate when the Outreach network is powered to indicate that an AFILS system is installed.

### A typical Pro-Range multiple input induction loop system

The illustration below shows a typical induction loop system for a place of worship requiring multiple audio inputs. It is designed to show all of the amplifier's inputs being used with a microphone connected to its **MIC.** input, a CD player connected to its **MIC./LINE** input and a series of Outreach plates connected to its **OUTREACH** socket. It should be noted that this diagram is provided for illustration purposes only and that in practice the same system (or a similar system for a different application) could just as easily be achieved using a different layout and/or a different configuration of inputs.

#### Induction loop amplifier (1)

Designed to be free-standing or, if required, wall or rack mounted using our optional PDA/WM or PDA/RM kits.

#### CD player (2) connected directly to the amplifier's MIC./LINE input using an appropriate lead

#### AMP professional microphone (3) connected directly to the amplifier's MIC. input using an appropriate lead

Positioned so it picks up the sound generated by the church organ

#### Loop cable (4)

Run the loop cable (see page 6 for recommended cable types) around the perimeter of the room at floor or ceiling height. Note that ceiling loops will not be practical in all applications, i.e. churches with high roofs.

If installing a floor loop, ensure the loop cable is adequately fixed and protected against being crushed in walkways or by furniture.

Note that flat copper foil loop tape is also available from your distributor.

#### 'Induction loop in use' sticker



Put the 'induction loop in use' sticker (supplied with the amplifier) where it can be clearly seen by members of the public. For large applications with multiple entrances, additional stickers can be purchased from your distributor.

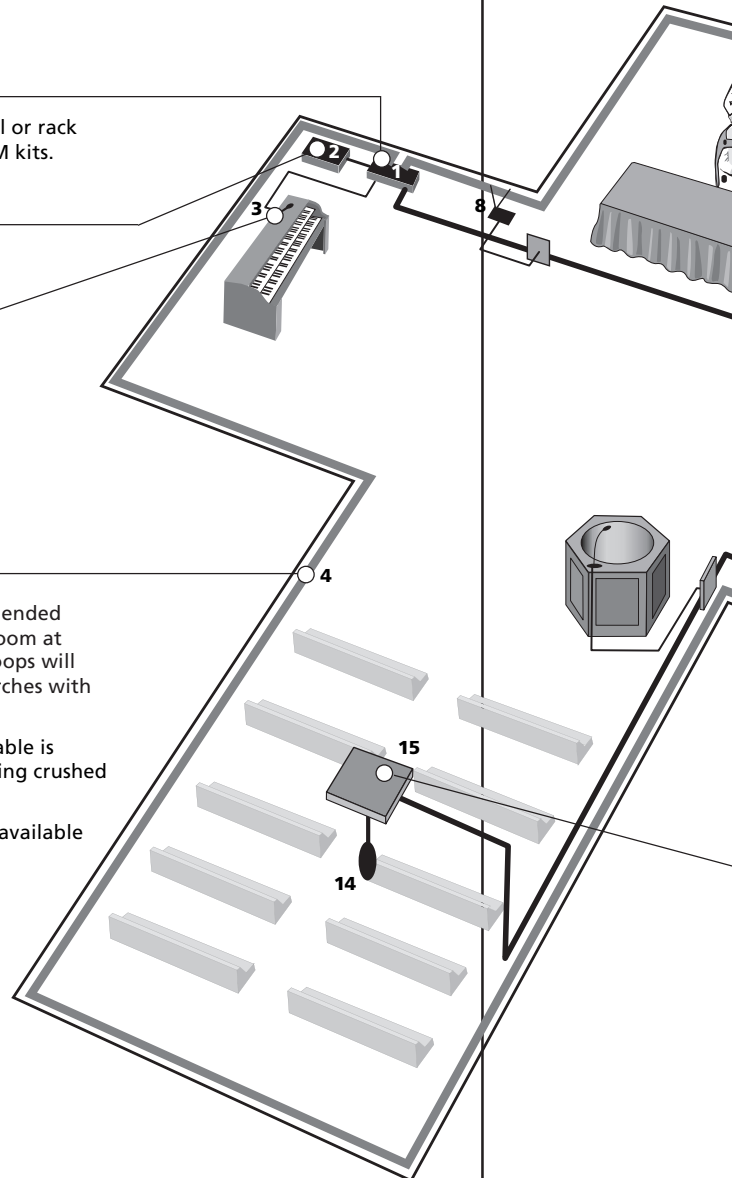



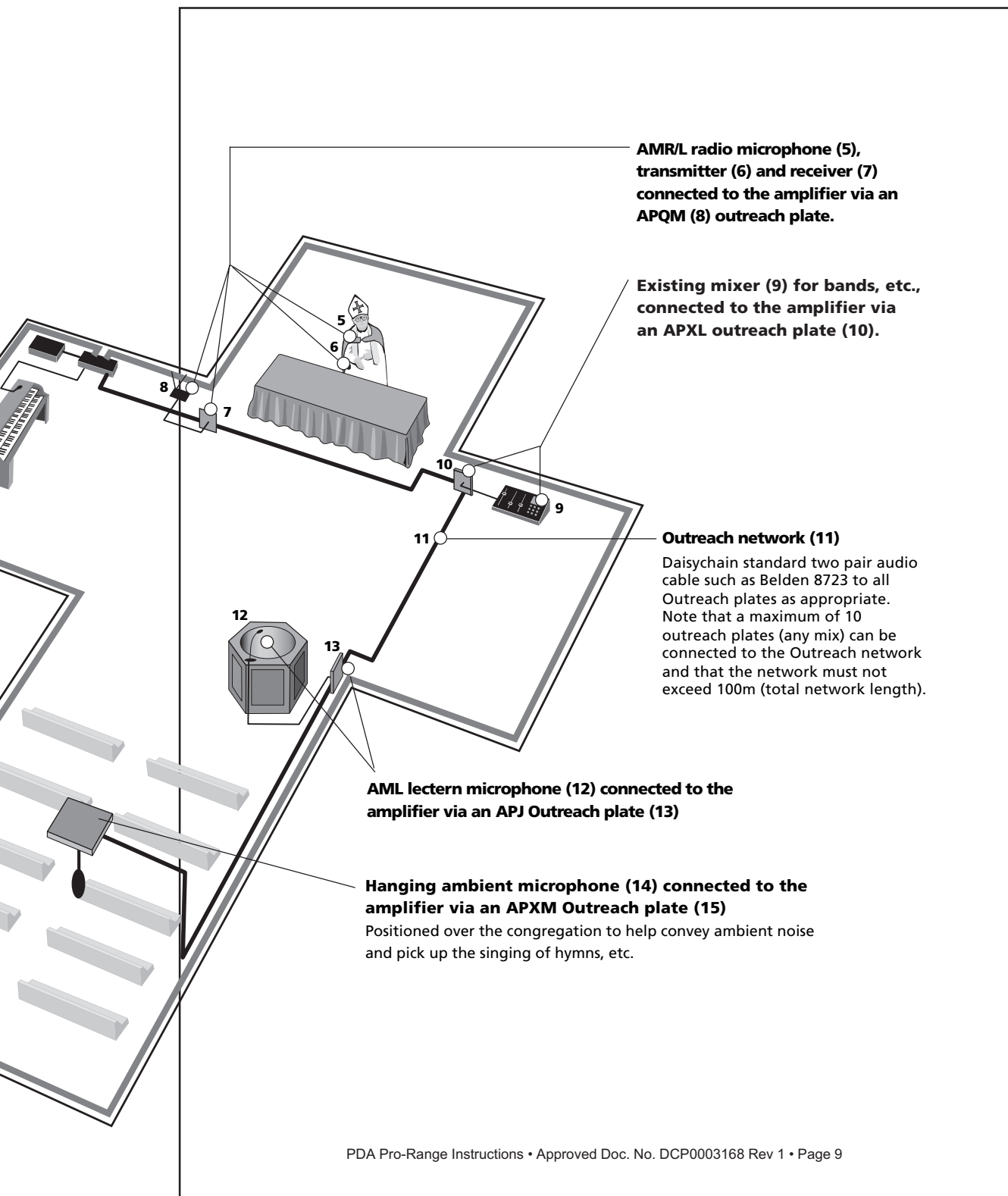

## Installation

### Safety precautions



**Please refer to the safety precautions below before attempting to make any connections or operating your PDA Pro-Range induction loop amplifier.**

Ensure the amplifier IS NOT located in areas with high ambient temperatures or high levels of humidity, moisture or dust. It SHOULD NOT be exposed to direct sunlight or water nor be placed next to vibrating or heat-generating equipment.

The amplifier should never be covered with any object that could impede the flow of air to its cooling fan and we recommend there is a gap of at least 50mm (2 inches) to the rear and sides of the amplifier.

DO NOT dismantle or attempt to modify the amplifier in any way. No user-serviceable fuses or parts are included inside the amplifier. For repair, consult your distributor/supplier.

Ensure the a.c. power lead, loop cable and all relevant audio/microphone lead(s) are fixed securely into position before operation. Do not leave any trailing leads.

The a.c. power lead has a moulded plug. If you need to remove the plug, it must be replaced with one that meets BS1363, or equivalent, fitted with a 3A fuse. As the colours of the wires in the lead may not correspond to the markings in your plug, connect as follows:-

**Green and yellow wire** to 'E' mark, '⊕' mark, 'Green' mark or 'Green and Yellow' mark

**Blue wire** to 'N' mark, 'Black' mark or 'Blue' mark

**Brown wire** to 'L' mark, 'Red' mark or 'Brown' mark

### Mounting the amplifier

The amplifier has been designed so it can be left free-standing on a shelf, tabletop or desk, or, alternatively, wall or rack mounted using one of our optional PDA/RM 19" rack mounting kits or PDA/WM wall-mounting kits.

Always refer to the **Safety precautions** (above) before deciding on a location for the amplifier and note that more detailed information on wall or rack mounting is supplied with each optional mounting kit.

## Connecting and testing the system

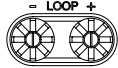

**IMPORTANT : DO NOT POWER UP THE SYSTEM UNTIL STEP 7 (OVERLEAF). THE AMPLIFIER SHOULD NOT BE OPERATED WITHOUT A LOOP CONNECTED TO IT.**

- 1 Install the loop - see **Planning the System**, pages 6 to 9, for example layouts and positioning advice.
- 2 Before connecting the loop to the amplifier, use a multimeter to check the loop is not shorted to ground at any point. It WILL almost certainly damage the amplifier if it is.
- 3 Connect the loop to the amplifier's heavy duty binding posts using bare wire ends, 4mm plugs or spade terminals as appropriate. 
- 4 Connect an input signal source (microphone, line, outreach or any combination of these) to the amplifier as shown below.

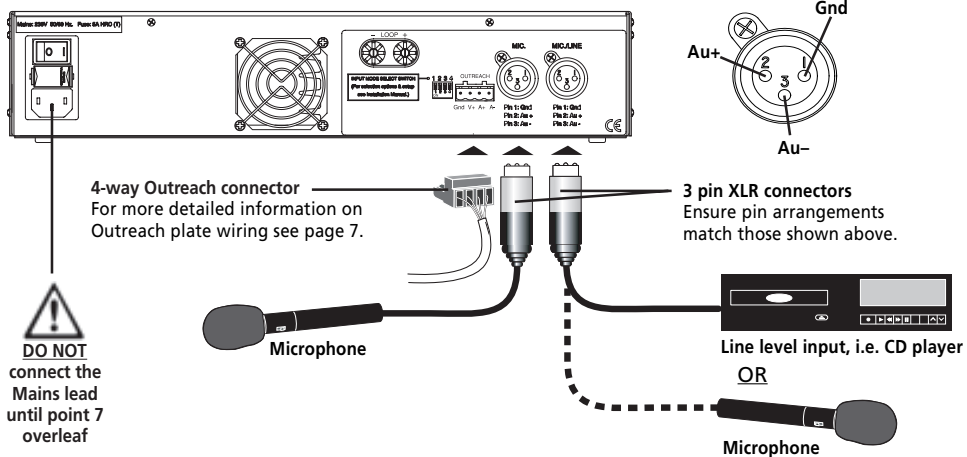

- 5 Set the Input Mode Select Switches to their correct positions with reference to the table below. Note that the position of the switches will depend upon the type of inputs that are connected to the amplifier.

SW1	OFF (up)	ON (down)	Input
1	11V phantom power off	11V phantom power on	MIC.
2	11V phantom power off	11V phantom power on	MIC./LINE
3	Line operation	Mic. operation	MIC./LINE
4	----- Switch 4 has no function -----		



Note that if Switch 3 is in the OFF (up) position (**MIC./LINE** input set for line operation), Switch 2 **MUST** also be in the OFF (up) position (11V phantom power off). Failure to do so could result in damage to any line level equipment you connect to the amplifier.

- 6** Ensure the amplifier's **DRIVE, METAL COMPENSATION** and three **LEVEL** controls are set to minimum by turning them fully anti-clockwise.



- 7** Connect the AC power lead (supplied) to a 230V a.c. wall socket and the amplifier's 230V socket as shown, flick the rocker switch to the on (I) position and ensure the amplifier's red **POWER** indicator is lit.

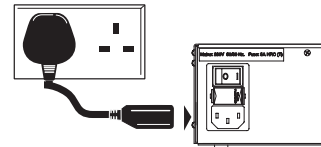

- 8** With all relevant audio input source(s) active, increase the appropriate **LEVEL** controls until the **LOW** compression indicator is lit most of the time and the **HIGH** compression indicator illuminates with peaks in the input signal(s).

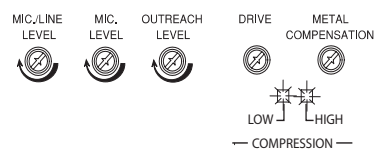

Note that it is perfectly acceptable for the **HIGH** indicator to be lit two thirds of the time but not for them to be permanently lit.

**TIP:** If you are using the mic., mic./line and outreach input at the same time, adjust the level control on each outreach plate to achieve an acceptable balance.

- 9** Adjust the **DRIVE** control by turning it clockwise until the first three lights on the amplifier's loop strength meter start to illuminate.

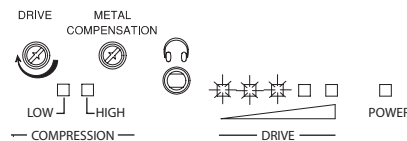

- 10** Using an induction loop listening device, listen to the loop signal in the centre of the loop. If the signal level is not acceptable, adjust the **DRIVE** control in small increments until it is. When you are satisfied with the signal in the centre of the loop, move around the room to ensure coverage is consistent throughout.



Pay particular attention to areas where hearing aid users are likely to gather and take note of the following warning and advice tips:-



The loop strength meter's red peak indicator (the fifth LED on the gauge) should only illuminate with peaks in the input signal - if it is lit too frequently, the audio sound quality will be distorted and the amplifier may overheat. If this is the case, try adjusting the layout of the loop and/or consider purchasing a more powerful PDA range amplifier.



If it is impossible to illuminate all of the indicators on the loop strength meter even when the **DRIVE** control is turned fully clockwise, the thickness (CSA) of the induction loop cable used may be insufficient for the job. Please refer to **Loop cable selection**, page 6, to ensure you are using the recommended cable for the application.

continued on page 13

## 11 **Metal Compensation Control**

If a large amount of metal is present in or near the induction loop, you may find the sound you hear through the loop listening device is 'woolly' or 'dull'. This is caused by the metal in the room absorbing the magnetic field at a rate that increases with frequency, i.e. high notes are absorbed more than low notes resulting in a 'muffled' sound. If this is a problem, try turning the amplifier's **METAL COMPENSATION** control clockwise in small increments until a natural balance is achieved. Please note however that due to the metal absorbing power from the amplifier, its area of coverage will be reduced and further reduced as the **METAL COMPENSATION** control is turned clockwise.

Note that when testing the installation with a loop listening device, you may hear a slight 'humming' noise in the background. This IS NOT a fault with the induction loop system but a common occurrence caused by mains wiring. This hum will normally NOT be heard by hearing aid users as most modern hearing aids have filters which cancel this noise out.

---

For compliance with BS7594 (the code of practice for audio-frequency induction loop systems), we recommend you also check the system using a pink noise generator and magnetic field strength meter.

BS7594 recommends that the magnetic field strength of an AFILS over a covered area should be 100mA RMS average peaking to 400mA per metre. The most efficient way of ensuring this requirement is met is to measure the magnetic field strength of a steady output from the induction loop amplifier.

Unlike music or speech (both of which provide a variable sound output from which it is virtually impossible to obtain an accurate RMS reading), pink noise has an equal and constant average amount of energy content per octave of bandwidth. When fed into an AFILS system, pink noise therefore gives a constant magnetic field strength which can be easily and accurately measured using a magnetic field strength meter.

The following items of cost-effective PDA RANGE test equipment can be used to verify both the audio quality and the magnetic field strength of any AFILS system. ALWAYS refer to the more detailed information supplied with each unit before starting any tests.

P-Ngen Pink noise generator (part no. PNGN)

FoSmeter H Combined magnetic field strength meter & loop listener (part no. AHM/H)

FoSmeter+ Combined pink noise generator & magnetic field strength meter (part no. AMPN)

Headphones for use with FosMeter H (part no. HEAD1)

Contact your PDA RANGE distributor/supplier for pricing details.

## PDA Pro-Range technical specifications

### POWER

230-240 V a.c. mains (PDA200/2 <150 VA; PDA500/2 <225 VA; PDA1000/2 <300 VA)  
(IEC 320 fused mains lead supplied)

### INPUTS

#### Line (3 pin XLR type)

**Input impedance:** 6k $\Omega$  + or - input to ground.

**Sensitivity:** 200mV - 2.5V RMS balanced or unbalanced.

#### Microphones (3 pin XLR type)

**Input impedance:** 6k $\Omega$  + or - input to ground.

**Sensitivity:** 1 - 8 mV balanced

**Phantom power:** 12V switchable (on/off)

#### Outreach (Four-way Weidmuller connector. Plug type BL5. 08/4)

**Input impedance:** >10k

**Sensitivity:** 500mV - 6V RMS balanced

**Outreach Power:** 16 - 21 V d.c. is available via the amplifier's Outreach Socket. A self-resetting fuse protects this output from any accidental overload.

### OUTPUT

**Type:** Current mode.

**Loop connector:** Four way binding posts

**Recommended loop impedance:** 0.5 - 1 Ohm @ 1KHz. Will drive higher impedance loops with reduced area of coverage.

**Loop drive current @ 1 Ohm:** PDA200/2 - 6A; PDA500/2 - 9A; PDA1000/2 - 12A.

#### Peak loop drive current (measured over 5mS integration time):

PDA200/2 - 8 Amps @ 1 Ohm, 13Amps @ 0.5 Ohm;

PDA500/2 - 12 Amps @ 1 Ohm, 19 Amps @ 0.5 Ohm;

PDA1000/2 - 14 Amps @ 1 Ohm, 24 Amps @ 0.5 Ohm

**Recommended cable gauge:** See graph on page 6.

**Headphones:** 3.5mm jack socket allows monitoring of the loop signal via >32 Ohm headphones.

### COVERAGE

The table below gives the maximum area coverage for a 400mA/M field strength +/- 1dB.

Pro-Range model no.	Max. short term current	Area of coverage	
		Square	Rectangular (2:1 aspect ratio)
200/2	6A	200m <sup>2</sup>	240m <sup>2</sup>
500/2	9A	500m <sup>2</sup>	600m <sup>2</sup>
1000/2	12A	900m <sup>2</sup>	1100m <sup>2</sup>

### PERFORMANCE

**Frequency response:** 20Hz - 14 KHz + - 3dB

**Distortion:** Less than 0.5 %

**Signal to noise ratio:** Better than -65dB any input

**Compressor:** Gives dynamically variable compression ratio from 1:1 (no compression) to 17:1 when both compression LEDs are lit. In normal use, with the first compression LED lit for part of the time, the compressor has a “soft knee” characteristic and provides a small degree of compression for signals which only just light the first LED but a large degree of compression for louder peaks.

**Attack time:** Approx. 10mS. **Release time:** Approx. 2.2S

**Metal Compensation:** True 3dB /octave design counteracts frequency dependent absorption by metal in the proximity of the installation over a bandwidth of approximately 100Hz – 10KHz.

#### INDICATORS

**Power on LED:** Red

**Loop current:** A five LED bar graph type meter is provided to allow monitoring of loop current output and assist in setting up the amplifier. This is provided by monitoring true output current rather than from a line level derived signal. The calibration is as follows:

PDA200/2:      1st led = 75mA      2nd led = 375mA      3rd led = 1.5A      4th led = 3.75A      5th led = 6A

PDA500/2:      1st led = 112mA      2nd led = 562mA      3rd led = 2.25A      4th led = 5.6A      5th led = 9A

PDA1000/2:      1st led = 150mA      2nd led = 750mA      3rd led = 3A      4th led = 7.5A      5th led = 12A

Accuracy - +10%

This meter has PPM type characteristics i.e. fast attack and slow release. This allows easy reading of fast peaks.

**Compression:** A two LED display is provided for indication of signal compression. The first LED shows the beginning of compression whilst the second indicates very high compression levels have been reached.

#### REAR PANEL CONTROLS

On/Off switch incorporated into IEC mains inlet.

Four way piano key style DIP switch selects Phantom power for mic 1 & 2 XLR inputs and switches XLR input 1 between Line and Microphone settings. The fourth of the 4-in-line switch is not connected.

#### FRONT PANEL CONTROLS

Level controls for XLR 1 (Line/Mic switchable), XLR 2 (Mic) and Outreach.

These can be used individually or any of them together, in which case they act as a three input mixer.

Drive control: Sets level of amplifier output current supplied by the amplifier. Analogous to the volume control on a standard voltage output amplifier but NOT designed to be adjusted once set to the correct value for any given installation.

Metal compensation control. When fully anti-clockwise has no effect on the signal. When turned clockwise imparts a rising 3dB/octave characteristic to the frequency response of the amp. This tends to counteract the effect of metal in proximity to the loop. Where there is some distance between the loop and any metal, or the quantity of metal is small, an intermediate setting of the control should be found which provides a satisfactory tonal balance.

#### COOLING REQUIREMENTS

The PDA1000/2 and PDA500/2 have thermostatically controlled cooling fans, which are activated when the amplifier’s internal heatsink temperature reaches approximately 56°C. It is therefore normal for the fans to be heard switching on and off in everyday use.

The PDA200/2 model does not require a cooling fan, as it does not generate as much heat as the larger models.

In all cases the amplifiers should be operated in a cool environment, away from sources of heat and should never be covered with any object that could impede the flow of cooling air.

#### DIMENSIONS & WEIGHT

**All models:** Length – 380mm; Depth – 220mm; Height – 80mm

**Weight:** PDA200/2 – 3.74Kg, PDA500/2 – 3.46Kg; PDA1000/2 – 4.54Kg

## Spares and accessories

### PDA PRO-RANGE AMPLIFIERS AND MOUNTING KITS

PDA200/2	200m <sup>2</sup> free-standing professional induction loop amplifier
PDA500/2	500m <sup>2</sup> free-standing professional induction loop amplifier
PDA1000/2	900m <sup>2</sup> free-standing professional induction loop amplifier
PDA/WM	Wall mounting kit for PDA200/2, 500/2 or 1000/2 amplifier
PDA/RM	19" Rack mounting kit for PDA200/2, 500/2 or 1000/2 amplifier

### INDUCTION LOOP CABLE - see page 6 for further information

LOOP1/B	100m reel 0.5mm <sup>2</sup> single core black loop cable
LOOP1/W	100m reel 0.5mm <sup>2</sup> single core white loop cable
LOOP2/B	100m reel 1.0mm <sup>2</sup> single core black loop cable
LOOP2/W	100m reel 1.0mm <sup>2</sup> single core white loop cable
LOOP3/B	100m reel 1.5mm <sup>2</sup> single core black loop cable
LOOP3/W	100m reel 1.5mm <sup>2</sup> single core white loop cable
LOOP4/B	100m reel 2.5mm <sup>2</sup> single core black loop cable
LOOP4/W	100m reel 2.5mm <sup>2</sup> single core white loop cable
FLAT1005	100m x 0.5mm <sup>2</sup> insulated copper tape (flat loop cable for under carpets)
FLAT2005	100m x 1.0 mm <sup>2</sup> insulated copper tape (flat loop cable for under carpets)
FLAT3005	100m x 1.5mm <sup>2</sup> insulated copper tape (flat loop cable for under carpets)
TAPE	50m white synthetic fibre tape (used to protect flat loop cable)

### OUTREACH PLATES - see page 7 for further information

APM	Omni-directional plated microphone, for wall/ceiling/desk mounting
APL	Double phono line level outreach plate
APJ	3.5mm mono jack mic. level outreach plate
APQM	6.35mm jack mic. level outreach plate
APQL	6.35mm jack line level outreach plate
APXM	XLR 3 pin mic level outreach plate
APXL	XLR 3 pin line level outreach plate
API	AFILS active indicator light
BELDEN/10	10m Belden 8723 four core screened cable for use with outreach plates
BELDEN/25	25m Belden 8723 four core screened cable for use with outreach plates

### INDUCTION LOOP TESTING EQUIPMENT - see page 13 for further information

PNGN	Pink noise generator (requires PP3 battery and AL3 connection lead)
AHHM	FoSmeter magnetic field strength meter (requires PP3 battery)
AMPN	FoSmeter Plus combined pink noise generator & magnetic field strength meter (requires PP3 battery and AL3 connection lead)
AHHM/H	FoSmeter H combined magnetic field strength meter & loop listener (requires HEAD1 32 Ohm headphones)
HEAD1	32 Ohm headphones for use with AHHM/H
AL3	3.5mm jack to bare ended lead (connects PNGN or AMPN to a pro-range amplifier's outreach socket)

### INDUCTION LOOP ANCILLARIES

APT	Loop connector plate (for the termination of induction loop cable)
LEST	100V line (i.e PA system output) to 0db (775mV line level) convertor
TEAR10	Pack of 10 self-adhesive 'induction loop in use' stickers

© 2004. Errors and omissions excepted. The manufacturer of this equipment operates a policy of continuous improvement and reserves the right to alter product specifications at its discretion and without prior notice.